



Agilent CrossLab CS Electronic Leak Detector

Operation Manual



Notices

© Agilent Technologies, Inc. 2024

No part of this manual may be reproduced in any form or by any means (including electronic storage and retrieval or translation into a foreign language) without prior agreement and written consent from Agilent Technologies, Inc. as governed by United States and international copyright laws.

Manual Part Number

G6693-90000

Edition

Third edition, May 2024

Printed in USA

Agilent Technologies, Inc.

412 Ying Lun Road

Waigaoqiao Freed Trade Zone

Shanghai 200131 P.R.China

Warranty

The material contained in this document is provided "as is," and is subject to being changed, without notice, in future editions. Further, to the maximum extent permitted by applicable law, Agilent disclaims all warranties, either express or implied, with regard to this manual and any information contained herein, including but not limited to the implied warranties of merchantability and fitness for a particular purpose. Agilent shall not be liable for errors or for incidental or consequential damages in connection with the furnishing, use, or performance of this document or of any information contained herein. Should Agilent and the user have a separate written agreement with warranty terms covering the material in this document that conflict with these terms, the warranty terms in the separate agreement shall control.

Safety Notices

CAUTION

A CAUTION notice denotes a hazard. It calls attention to an operating procedure, practice, or the like that, if not correctly performed or adhered to, could result in damage to the product or loss of important data. Do not proceed beyond a CAUTION notice until the indicated conditions are fully understood and met.

WARNING

A WARNING notice denotes a hazard. It calls attention to an operating procedure, practice, or the like that, if not correctly performed or adhered to, could result in personal injury or death. Do not proceed beyond a WARNING notice until the indicated conditions are fully understood and met.

Leak Detector

Introduction	5
Power/Mode button	5
Enter/Clear/Toggle button	6
Switching the leak detector On and Off	7
Notes, Cautions, and Warnings	8
Product Specifications	11
Detection Sensitivity to Gases	12
Operating Modes	13
Warm Up mode	13
Detection mode	14
Info mode	16
Detecting Leaks	24
Replacing and Servicing the Probe Filter	25
USB interface	26
Warning and Error Indications	28
Warning indication	28
Error indication	28
Low battery indication	29
Power Indications	30

Leak Detector

Installing and Replacing the Cartridge	31
Installing the cartridge	31
Swapping or replacing the cartridge with ADM	
Flow Meter cartridge	32
Replacing the Batteries	34
Upgrading the Firmware	36
Using the Leak Detector Stand	36
Safety and Regulatory Certification	37
Class A EMC certification	37
Disposal	37

Introduction

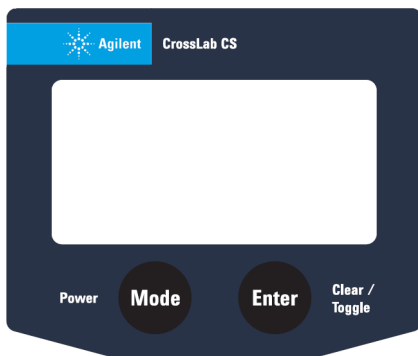

Figure 1. The Agilent CrossLab CS leak detector front screen buttons.

The Agilent leak detector is controlled with two buttons on the front of the instrument directly below the screen, as shown in **Figure 1**. The functions of these buttons are described in this section.

Power/Mode button

The Power/Mode button is used to switch the leak detector on and off, as well as to scroll through and select different operational modes.

- To turn on the instrument, briefly press and release the Power/Mode button.
- To turn off the instrument, press and hold the Power/Mode button for three seconds.
- To scroll through the available modes, when the instrument is on, briefly press and release the Power/Mode button.

Leak Detector

Enter/Clear/Toggle button

Enter/Clear/Toggle button

The Enter/Clear/Toggle button is used to access additional functionality within the operating modes.

- To reset the baseline of detection in **Detection** mode, briefly press and release Enter/Clear/Toggle button.
- To change the settings in **Info** mode, press and hold the Enter/Clear/Toggle button for two seconds.

Leak Detector

Switching the leak detector On and Off

Switching the leak detector On and Off

With the Leak Detector powered off, briefly press and release Power/Mode button to turn the unit on. The screen will flash the words **Leak Detector** for approximately three seconds, then begin operating.



Figure 2. The initial screen display for the Agilent leak detector.

With the unit powered on, press and hold the Power/Mode button for three seconds to power down the unit.

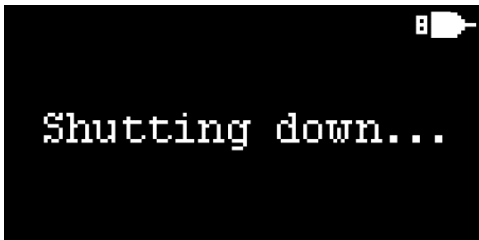

Figure 3. The shutdown screen for the Agilent leak detector.

Notes, Cautions, and Warnings

NOTE

- The tubing is not replaceable. Do not attempt to remove the tubing.
 - The filter is the only serviceable part in the leak detector cartridge.
 - Annual calibration for the leak detector cartridge is not necessary.
 - Update to the latest firmware if the leak detector cartridge is being used with ADM Flow Meter mainframe with firmware version 1.2.1911.1501 and below.
-

CAUTION

- Do not use the leak detector to detect corrosive gases.
 - Do not expose the probe tip to extreme sources of heat.
 - Do not use the leak detector to probe in areas where there are solvents or liquids (such as snoop).
 - Do not use the leak detector in temperatures outside of its specified operating range.
 - Do not use the leak detector in high humidity environments outside of its specified humidity range.
 - The probe should not be misused for other purposes except to conduct sniffing in suspected leak areas.
-

WARNING

- Use only a 5 V DC, 0.5 A USB power source and the supplied USB cable to run this device.
 - Do not use the leak detector in hazardous environments where there are large leaks of flammable gases.
 - Do not use the leak detector as safety equipment.
-

Leak Detector

Notes, Cautions, and Warnings

WARNUNG

- Verwenden Sie zum Aufladen dieses Geräts ausschließlich eine 5v DC, 0,5A USB-Stromquelle und das mitgelieferte USB-Kabel.
 - Verwenden Sie den Lecksucher nicht in gefährlichen Umgebungen, in denen große Mengen an brennbaren Gasen austreten.
 - Verwenden Sie den Lecksucher nicht als Sicherheitsausrüstung.
-

ATTENTION

- Utilisez uniquement une source d'alimentation USB 5 V CC, 0,5 A et le câble USB fourni pour charger cet appareil.
 - N'utilisez pas le détecteur de fuites dans des environnements dangereux où de grandes fuites de gaz inflammables existent.
 - N'utilisez-pas le détecteur de fuites comme équipement de sécurité.
-

ATTENZIONE

- Per caricare questo dispositivo, utilizzare solo una fonte di alimentazione USB da 5 V CC, 0,5 A e il cavo USB in dotazione.
 - Non utilizzare il rilevatore di fughe in ambienti pericolosi in cui vi siano importanti fughe di gas infiammabili.
 - Non utilizzare il rilevatore di fughe come apparecchiatura di sicurezza.
-

ADVERTENCIA

- Para cargar este dispositivo, use solamente una fuente de alimentación USB de 0,5A, DC 5V y el cable de alimentación suministrado.
 - No utilice el detector de fugas en entornos peligrosos en los que existen grandes fugas de gases inflamables.
 - No use el detector de fugas como equipo de seguridad.
-

Leak Detector

Notes, Cautions, and Warnings

警告

- 仅使用 5v DC、0.5A USB 电源和随附的 USB 电缆为本设备充电。
 - 请勿在有大量易燃气体泄漏的危险环境中使用检漏仪。
 - 请勿将检漏仪用作安全设备。
-

Product Specifications

Table 1 Agilent leak detector specifications

Parameter	Value
Sensitivity*	Helium 0.003 mL/min in atmosphere
Operating Temperature Range	0 to 45 °C (non-condensing)
Storage Temperature Range	-15 to 50 °C
Power	(three) AA batteries (alkaline), or USB power
Display	128 × 64 pixels monochrome with 16 gray scales

* When verified with calibrated leak source at ambient temperature of 20 to 26 °C at standard atmospheric pressure.

Detection Sensitivity to Gases

The sensitivity of detection to other gases depends on the relative thermal conductivity of the target gas with respect to ambient air. Below is a table of the calculated minimum detectable leak.

Table 2 Calculated minimum detectable leak

Gas	Minimum Detectable Leak Rate (mL/min)	Level Indicator
Hydrogen	0.0025	Filled bar
Helium	0.003	Filled bar
Methane	0.014	Filled bar
Nitrogen	1.0	Empty bar
Argon	0.03	Empty bar
Carbon dioxide	0.03	Empty bar

Operating Modes

With the leak detector switched on, briefly press the Power/Mode button to scroll through different operational modes.

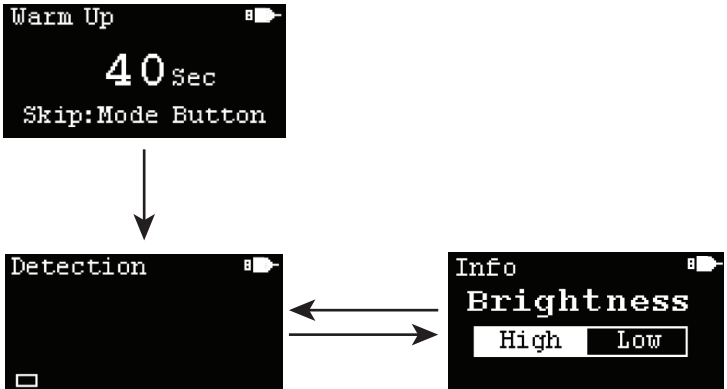

Figure 4. Example of warm up screen and scroll to operational modes.

The available operational modes are as follows:

Warm Up mode

This is the default mode on power up. The leak detector warms up for 50 seconds when turned on. The warm up process can be skipped by briefly pressing and releasing the Power/Mode button. However, to guarantee accuracy in **Detection** mode, allow for the completion of the warm up process. After the warm up is complete, the leak detector will switch to **Detection** mode automatically and is ready for use.

Detection mode

In this mode, the leak detector is ready to detect a gas leak. When the probe is measuring ambient air, the first bar alternating between a filled bar and an empty bar indicates that the leak detector is stable. Press the Enter/Clear/Toggle button to clear the bars if it is not alternating between a filled and an empty first bar.

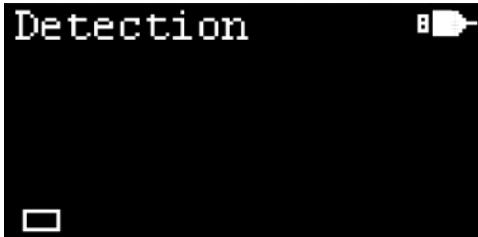

When a gas leak is detected, bar levels are displayed on the screen. The number of bar levels is proportional to the extent of the leak, and a maximum of eight bar levels can be displayed, indicating a large leak is detected. There are two types of bar levels to indicate the type of gas entering the detector:

Filled bar – Gas leak for gases with higher thermal conductivity than air.



Leak Detector

Detection mode

Empty bar – Gas leak for gases with lower thermal conductivity than air.

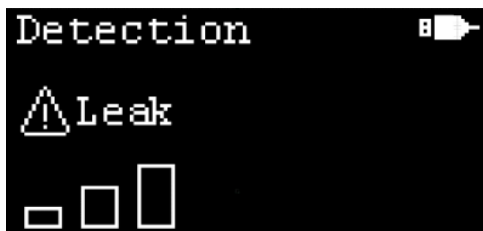

When the number of bar levels is greater than two, the leak alert sign will blink on the screen to give a visual alert, and the buzzer will sound to give an audible alert.

When probing ambient air, false readings of bars may be displayed on the screen. This may be due to tip drift. To perform a reset and baseline correction, hold the probe in ambient air for 2 seconds, then press and release the Enter/ Clear/Toggle button. After the correction, the number of bar levels is reset to zero and **Recalibrated** is displayed on the screen to indicate that the leak detector is recalibrated.

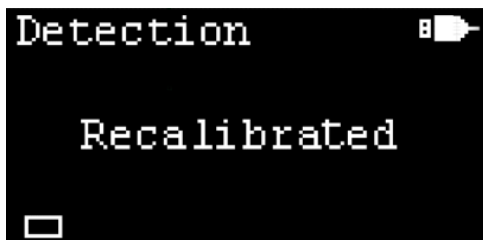

Info mode

Info mode provides details on the leak detector and the currently installed cartridge, including the filter expiration date. In addition, **Info** mode controls settings such as the display brightness level and turning the buzzer on and off.

To access Info mode:

- 1 Briefly press and release Power/Mode button until **Info** mode is observed on the screen.
- 2 Once in **Info** mode, briefly press and release the Enter/Clear/Toggle button to scroll through the available pages.

Display brightness

Display brightness can be set to high or low.

To change the display brightness setting:

- 1 With **Info** mode displayed, briefly press and release the Enter/Clear/Toggle button to cycle through available screens until the **Brightness** screen is displayed.
- 2 Press and hold the Enter/Clear/Toggle button for two seconds to toggle between **High** and **Low** options. The screen brightness changes based on the selected option.



Leak Detector

Info mode

Buzzer

When the leak detector is on, the buzzer setting defaults to **On**. This means that the leak detector is able to give an audible alert when the number of bar levels displayed are greater than two.

To change the buzzer setting:

- 1 With **Info** mode displayed, briefly press and release the Enter/Clear/Toggle button to cycle through available screens until the **Buzzer** screen is displayed.
- 2 Press and hold the Enter/Clear/Toggle button for two seconds to toggle between **On** and **Off** options. The buzzer function changes based on the selected option.



Auto off

In battery power mode, the unit defaults to "auto off" when the power is on. This means that every time the unit is activated, a "power-off" cycle begins, lasting for 10 minutes. The leak detector will operate continuously until it is manually turned off.

In USB power mode, the Auto off function is always off and the option to change the **Auto off** setting is disabled.

To change the Auto off setting:

- 1 With **Info** mode displayed, briefly press and release the Enter/Clear/Toggle button to cycle through available screens until the **Auto off** screen is displayed.

Leak Detector

Info mode

- 2 Press and hold the Enter/Clear/Toggle button for two seconds to toggle between **On** and **Off** options. The **Auto off** function changes based on the selected option.



Errors/Warnings

With **Info** mode displayed, briefly press and release the Enter/Clear/Toggle button to cycle through available screens until the **Error/Warning** screen is displayed.



Table 3 Error and warning code descriptions

Code	Type	Description	Troubleshooting
01 No Cal Info	Error	No calibration information	Contact Agilent Technical Support
02 No Verif	Error	Leak detector is not verified	Contact Agilent Technical Support
03 No Setting	Error	Leak detector settings missing	Contact Agilent Technical Support
04 No Cart	Error	No cartridge detected	Install a valid cartridge
05 No MF Info	Warning	No mainframe information	Contact Agilent Technical Support
06 I2C Fail	Error	Hardware communication failure	Reboot the leak detector
07 No Fltr Date	Warning	No filter date information	Contact Agilent Technical Support
08 Filter Exp	Warning	Filter expired	Renew the filter and reset the filter new date
09 Low RTC Bat	Warning	RTC (real time clock) backup battery low	Contact Agilent Technical Support
10 Zero Fail	Error	Baseline correction error	Reboot the leak detector
11 Need Zero	Error	Large voltage drift because voltage out of range	Press the Clear button in Detection mode
12 Ver Mismatch	Error	Firmware version mismatch with cartridge version	Upgrade the firmware to latest version
13 Invalid Cart	Error	Unable to identify cartridge types	Contact Agilent Technical Support

Leak Detector

Info mode

Filter date information

With **Info** mode displayed, briefly press and release the Enter/Clear/Toggle button to cycle through available screens until the **Filter** screen is displayed.

The **Filter** screen displays date information about the currently installed cartridge. This includes the filter new date and filter expiry date which is one year from filter new date. In addition, there is a rectangular bar as a graphic representation of the remaining usage period of the filter.



When the filter is expired, the rectangular bar is fully filled and **Expired!** is blinking in the rectangular bar to alert the user.



Filter exchange

The **Filter Exchanged** screen confirms that the leak detector is prepared for a filter exchange. By default, the **Filter Exchanged** screen is hidden. It can be shown under two scenarios:

- 1 The **Filter Exchanged** screen will automatically be added into the **Info** mode pages when the filter has expired.
- 2 The **Filter Exchanged** screen can manually be triggered by pressing and holding the Enter/Clear/Toggle button for two seconds while in the **Filter** page.

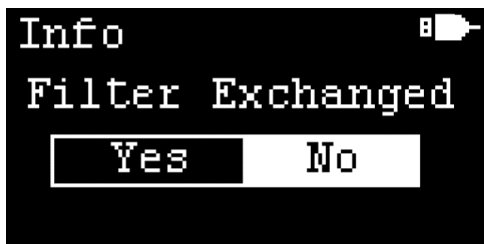

To change the **Filter Exchanged** option:

- 1 In the **Filter Exchanged** screen, press and hold the Enter/Clear/Toggle button for two seconds to toggle between **Yes** and **No** options.
- 2 With the desired option highlighted, briefly press and release the Enter/Clear/Toggle button to select the highlighted option.

Filter date reset

The **Reset Filter Date** screen allows the filter date to be updated when a new filter has been installed. The **Reset Filter Date** screen is hidden and can only be prompted when the **Yes** option in the **Filter Exchanged** screen is selected.



To change the **Reset Filter Date** option:

- 1 In the **Reset Filter Date** screen, press and hold the Enter/Clear/Toggle button for two seconds to toggle between **Yes** and **No** option.
- 2 With the desired option highlighted, briefly press and release the Enter/Clear/Toggle button to select the highlighted option.

After the **Yes** option is selected, the **Filter New** date is reset to the current Pacific time, and the **Filter Due** date is set to one year after the **Filter New** date.

Leak Detector

Info mode

Cartridge information

With **Info** mode displayed, briefly press and release the Enter/Clear/Toggle button to cycle through available screens until the Cartridge screen is displayed.

The Cartridge screen displays information about the currently installed cartridge. This includes the cartridge model number (**MDL**), serial number (**SN**) and key number (**Key**).

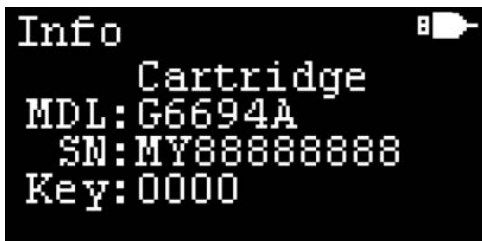

Mainframe information

With **Info** mode displayed, briefly press and release the Enter/Clear/Toggle button to cycle through available screens until the Mainframe screen is displayed.

The **Mainframe** screen displays information about the mainframe. This includes mainframe model number (**MDL**), serial number (**SN**) and firmware version number (**Ver**).

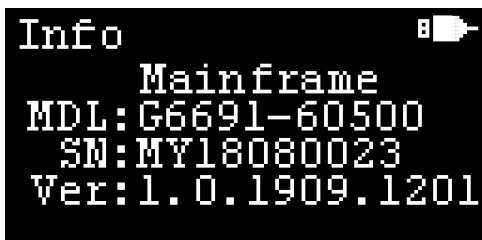

Detecting Leaks

- 1 Press and release the Power/Mode button to turn on the leak detector.
- 2 As the leak detector warms up, the pump can be heard. Wait until the warm up process is complete. The unit will switch to **Detection** mode automatically.
- 3 In **Detection** mode, check the stability of the unit by observing the bar levels on the screen. When stable, there is one bar, which alternates between a filled and an empty bar. The probe should be held up to ambient air for the unit to stabilize.
 - If there is more than one bar observed on the screen, briefly press and release the Enter/Clear/Toggle button to perform baseline correction.
 - Tip drift, temperature, and humidity fluctuations can impact the stability.
- 4 Place the probe near the gas connection to check for a leak. Avoid touching the probe tip against the fittings, tubing, and so forth as heat conduction may affect the leak detection results.
 - An audible alarm sounds when three or more bar levels are displayed (when the **Buzzer** is set to **On**).
- 5 Always press and release the Enter/Clear/Toggle button while the probe is held in ambient air. This should be done before probing in suspected leak areas to ensure accuracy.

Leak Detector

Replacing and Servicing the Probe Filter

Replacing and Servicing the Probe Filter

In the leak detector, there is filter installed in the probe to protect against particulate contamination. A clogged filter may cause a decrease in the detection sensitivity.

- 1 Hold the probe facing upwards and start to unscrew the probe tip.
- 2 Gently tap the male portion of the probe downwards to remove the mesh filter.
- 3 The mesh filter can be back flushed with compressed air or replaced entirely. (Order part number G6694-60005).
- 4 Back flush the probe tip if necessary.
- 5 Insert the mesh filter in position and screw the probe tip back on.

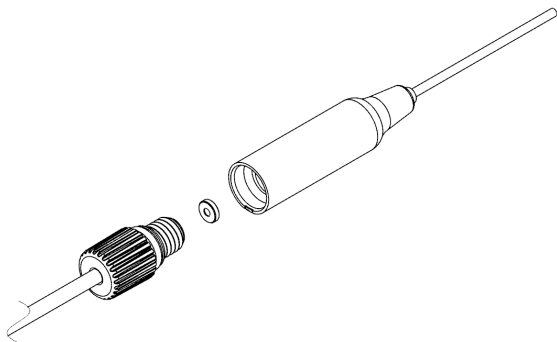

Figure 5. The probe filter, disassembled.

Leak Detector

USB interface

USB interface

Power can be supplied via the micro USB port located on the side of the unit.

NOTE

Using the USB port to supply power does not recharge the installed batteries.



The leak detector can communicate with a connected PC via the USB port. Data from the leak detector can be collected by connecting the USB port to your computer with the included USB cable. The leak detector USB driver will be needed for the instrument to communicate with your PC.

Leak Detector

USB interface

For details, please visit:

www.agilent.com/en/product/gas-purification-gas-management/gas-management/gas-leak-detector to download the driver and view the Connecting your leak detector to your PC instrument sheet.

NOTE

When using the data acquisition capability of the leak detector, you should disable the auto-off feature. See [Auto off](#) on page 17.

When the leak detector is being powered via the USB port, the battery icon on the screen is replaced by a USB connector icon.

When the leak detector is connected to PC software, the buttons on the leak detector are disabled. This is indicated by an icon to the left of USB icon on the screen.

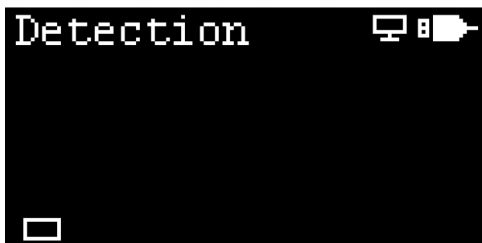

Warning and Error Indications

Various warning and error indications are displayed on the screen as appropriate. Each is described below.

Warning indication

A warning icon appears on the screen when the leak detector is being operated outside of acceptable conditions, when the filter is expired, when the RTC battery is low, and so on.

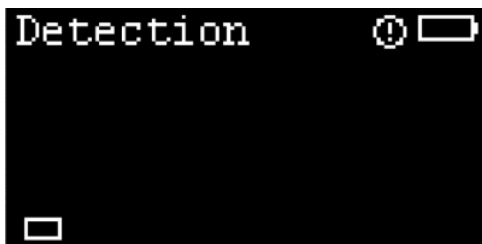

Error indication

When a hardware fault occurs, an error icon is displayed on the screen. This example shows when a cartridge is not detected in the leak detector.



Leak Detector

Low battery indication

Low battery indication

When the batteries need to be replaced, a low battery indication is displayed on the screen. When power is too low for operation, the leak detector will automatically shut down.

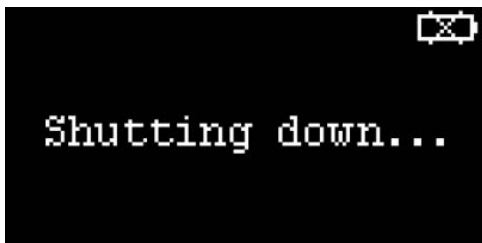

Leak Detector

Power Indications

Power Indications

The leak detector can be powered by batteries or through the USB port.

When powered by batteries, a battery icon will appear on the screen.

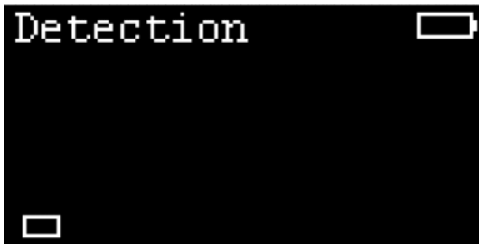

When powered through the USB port, a USB icon will appear on the screen.

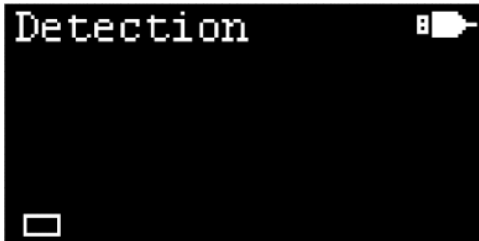

Installing and Replacing the Cartridge

Installing the cartridge

The CrossLab CS Mainframe is a platform that can accept the ADM Flow Meter Cartridge (part number G6692A) and Electronic Leak Detector Cartridge (part number G6694A).

NOTE

If you purchased the leak detector cartridge standalone, update your existing mainframe to the latest firmware when using your leak detector for the first time.

Remove the packaging on the Leak Detector Cartridge and insert into the CrossLab CS Mainframe slot. Hand tighten the two captive thumbscrews. The Leak Detector Cartridge comes with an attached sniffer probe and tubing which is not removable.

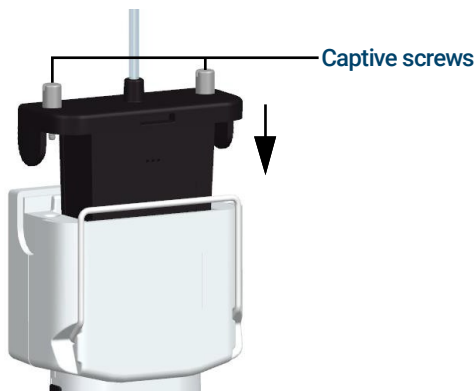

Figure 6. Leak Detector Cartridge being inserted into the CrossLab CS Mainframe slot.

Leak Detector

Swapping or replacing the cartridge with ADM Flow Meter cartridge

Swapping or replacing the cartridge with ADM Flow Meter cartridge

- 1 Press and hold the Power/Mode button for three seconds to power down the unit.
- 2 Loosen both captive thumbscrews completely and lift the cartridge out of the CrossLab CS Mainframe body.

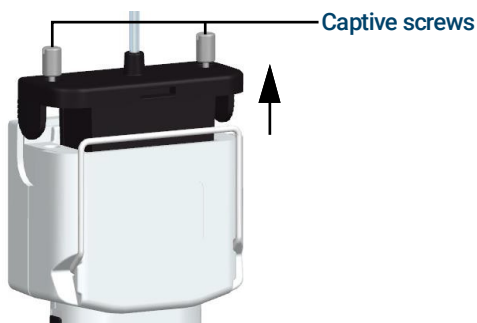

- 3 Insert cartridge of ADM Flow Meter in to the CrossLab CS Mainframe body. Hand tighten the two captive thumbscrews.



Leak Detector

Swapping or replacing the cartridge with ADM Flow Meter cartridge

- 4 Install new flexible tubing.

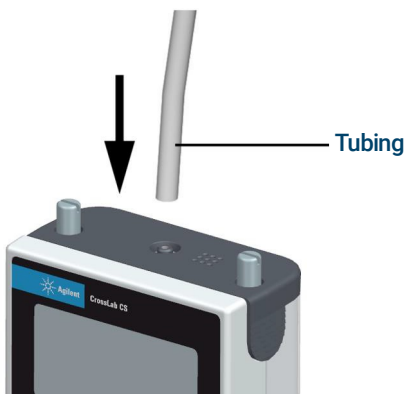

Leak Detector

Replacing the Batteries

Replacing the Batteries

NOTE

Recycle used batteries in accordance with all applicable governmental requirements for your location.

To replace the batteries, do the following:

- 1 Press and hold the Power/Mode button for three seconds to power off the leak detector.
- 2 Remove the battery cover by pressing in on the grooved thumb pad on the rear of the leak detector and sliding the battery cover off.

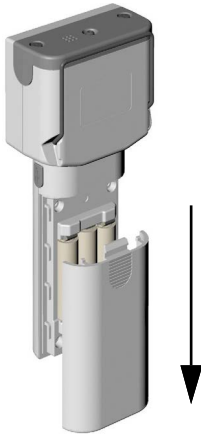

Leak Detector

Replacing the Batteries

- 3 Remove and replace the three AA batteries.

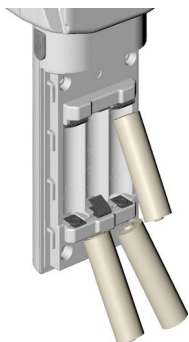

- 4 Reinstall the battery cover. Position the battery cover over the batteries and slide onto the flow meter until it locks in place.

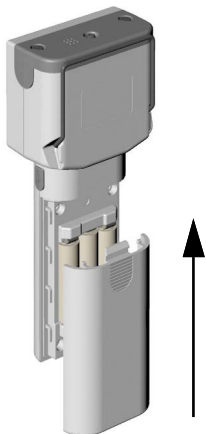

- 5 Briefly press the Power/Mode button to power on the leak detector.

Leak Detector

Upgrading the Firmware

Upgrading the Firmware

When a newer version of the flow meter firmware is available, you can upgrade to the latest version using your PC via the USB connection of the leak detector.

Please visit <http://www.agilent.com> for instructions.

Using the Leak Detector Stand

The flip down wire stand will give you a better viewing angle when the leak detector is placed above bench level. Pull the stand down until it is in the locked position.

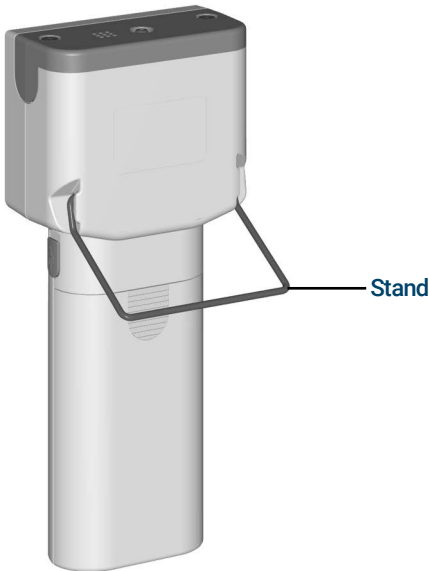

www.agilent.com

© Agilent Technologies, Inc. 2024

Third edition, May 2024



G6693-90000

